

**eArc SMF**  
**Installation Manual**  
**for Flat Roofs with aluminum/PVC rail**

# Contents

1.0 Summary.....	1
1.1 Disclaimer.....	1
1.2 Responsibility.....	1
1.3 Copyright and Trademark Information.....	1
1.4 Warranty Warnings.....	2
1.5 For Further Information.....	2
2.0 Safety precautions.....	2
3.0 Mechanical / electrical properties.....	4
4.0 Storage and unpacking.....	5
5.0 Installation.....	6
5.1 Module wiring.....	8
5.2 Grounding.....	8
6.0 Installation instructions.....	9
6.1 Module and tools.....	9
6.1.1 Module.....	9
6.1.2 Construction materials.....	9
6.2 Unpacking, Handling and Checking Precautions.....	10
6.3 Construction Precautions.....	11
6.4 Precautions and Tips for Gluing Modules.....	12
6.5 Construction plan.....	12
6.5.1 Cleaning the roof surface.....	12
6.5.2 Positioning.....	12
6.5.3 Brush primer (ignore this step if no primer required for the roof material) .....	13
6.5.4 Brush primer for PVC rail (ignore this step for the aluminum rail) ...	14
6.5.4 Paste rail.....	14
6.5.4 Laying modules.....	16

6.5.4 Joint of rails.....	19
6.6 Wiring and testing.....	21
7.0 Maintenance.....	23
Annex A.....	24
Electrical performance parameter.....	24
Annex B.....	25
Installation for different roof materials.....	25
Annex C.....	26
Cleaning agent.....	26
Annex D.....	27
Gluing operation specification.....	27
1. Gluing nozzle cutting.....	27
2. Electric glue gun adjustment.....	28
3. Gluing parameters.....	29
4. Structural adhesive form.....	30
Annex E.....	31
Unpacking.....	31

## 1.0 Summary

Thank you for purchasing Sunman eArc PV modules. This guide contains information regarding the installation and safe handling of Sunman (Zhenjiang) Company Limited eArc SMF PV system on Roofs. Sunman (Zhenjiang) Company Limited referred to as “SUNMAN”. Users and installers must read and strictly follow the installation manual. Failure to follow these safety guidelines can result in personal injury or property damage. The installation and operation of solar modules require specialized skills, and only professionals can do the job. Please read the safety and installation instructions before using and operating the modules. The installer must inform the end customer (or consumer) of the above matters accordingly.

### 1.1 Disclaimer

Sunman reserves the right to change this installation manual without prior notice. The changes and the latest installation manuals after the changes will be published in the resource center of the official Sunman website. Customers should always pay attention to the above changes. Sunman will not provide further notice.

Failure in operating according to instructions in this manual during installation (Including the changes announced on the official website of Sunman at the time of installation) will cause the warranty to be invalid.

Sunman does not guarantee any expressed or implied information contained in this manual.

### 1.2 Responsibility

Whether or not the installation of the modules is carried out in accordance with the instructions in the installation manual (Including the changes announced on the official website of Sunman at the time of installation), Sunman shall not be held legally responsible for any damages incurred during the installation process, including but not limited to personal and property damage resulting from the operation of the modules and the installation of the system.

### 1.3 Copyright and Trademark Information

Copyright © 2023 by Sunman (Zhenjiang) Company Limited. All rights reserved. eArc and the SUNMAN logo are trademarks of Sunman (Zhenjiang) Company Limited.

## 1.4 Warranty Warnings

WARRANTY VOID IF NON-SUNMAN-CERTIFIED HARDWARE IS ATTACHED TO eArc™ PV System.

## 1.5 For Further Information

For additional technical support documentation, please visit the Support page of the SUNMAN website at 'www.sunman-energy.com'.

## 2.0 Safety precautions



**WARNING:** Please read and understand all safety instructions before installing, wiring, operating, or maintaining modules. DC power is generated when the module is exposed to sunlight or other light sources. Direct contact with live parts of the module, such as terminals, whether connected or not, may result in personal injury or death.

### Safety rules

- All installation work must be in full compliance with local regulations and corresponding national or international electrical standards.
- Use insulated tools to reduce the risk of electric shock.
- Use appropriate protective measures (slip gloves, overalls, etc.) to avoid direct contact with workers at 30V DC or higher, while avoiding direct contact with sharp edges during installation to protect the operator's hands.
- Do not wear metal ornaments when installing, to avoid puncturing the modules and causing electric shock.
- If modules are installed or operated on rainy days, strong winds or dew mornings, appropriate protective measures should be taken to avoid injury to modules and workers.
- Children or unauthorized personnel are not allowed to access the installation area or module storage area.
- If the circuit breaker and overcurrent protection circuit breaker cannot be opened, or if the inverter cannot be turned off during the module installation or wiring, cover the array modules with opaque material to stop the power output.

- Do not use or install damaged modules.
- If the module surface is damaged or worn, direct contact with the surface of the module may result in electric shock.
- Do not attempt to repair any part of the module, there are no user-accessible components within the module.
- The cover of the junction box should remain closed at all times.
- Do not split the modules or move any part of the module.
- Do not artificially condense light on modules.
- Do not connect or disconnect modules when there is current in the module or external current.

### **3.0 Mechanical / electrical properties**

The rated electrical performance data for the modules is measured under standard test conditions (STC) of irradiance of 1000 W/m<sup>2</sup>, AM 1.5, and cell temperature of 25 °C. The specific electrical and mechanical performance parameters of Sunman eArc modules are included in Annex A of this installation manual. The main electrical performance parameters under STC conditions are also marked on the nameplate of each module. The maximum system voltage for all modules is 1500V.

In some cases, the current or voltage generated by the module may be greater than the optimal operating current or voltage of its standard test condition (STC). Therefore, when determining the component rating and load value, the module open circuit voltage and short circuit current at STC should be multiplied by 1.25. Please check with your local rules and regulations.

## 4.0 Storage and unpacking

### Precautions and general safety rules

- Store modules in a dry and ventilated environment.
- The modules must be transported in the package provided by Sunman and stored in the original package before installation. Please protect the packaging from damage. Open the package according to the recommended unpacking steps. Care must be taken during unpacking, shipping, and storage.
- Do not apply excessive loads on the modules or twist the modules.
- Do not carry the modules through the wires or junction boxes of the modules.
- Do not stand, climb, walk or jump on modules.
- Do not allow sharp objects to touch the modules. Scratches can directly affect the safety of the modules.
- Do not place the modules in an environment where there is no reliable support or is not fixed.
- Do not change the wiring method of the bypass diode.
- Keep all electrical connections clean and dry.

### Product identification

- Barcode: each individual eArc has a unique serial number. The serial number has 21 digits. The 1st to 4th digits are the module type for internal use, and 5th to 8th digits are the year code, and the 9th and 10th digits are the month code, and the 11th and the 12th digits are the week code, and the 13th and 14th digits are the month code, and the 15th to 17th digits are order number, and the 18th to 21th digits are the sequence codes. For example, xxxx20210415xxxxxxxx means the module was made in the 15th week of 2021. Each module has only one bar code. It is permanently attached to the interior of eArc and is visible from the top front of eArc. This bar code is inserted prior to lamination.



- There is a nameplate, which shows the model number, main electrical properties, safety specifications and certification indicator, on the back of each module.



## 5.0 Installation

### Precautions and general safety rules

- Before installing the modules, please contact the relevant department to obtain information about the installation site and the construction permit, and also comply with the installation and inspection requirements.
- Check the applicable building codes to ensure that the building to be installed and its structure (roof, facade, load-bearing, etc.) has sufficient load-bearing capacity.
- During installation, make sure that the modules are installed on a fire-resistant roof. According to UL790 standards, Sunman eArc modules are rated as fire rating C.
- The eArc modules are compliant with application level A (equivalent to safety level II, IEC 61730-1). This type of modules can be used in systems where the public is likely to come into contact with voltages greater than 50V or power greater than 240W.

### Environmental conditions

The modules are suitable for general climatic conditions, ie with reference to IEC 60721-2-1- Classification of environmental conditions Part 2-1: Environmental conditions occurring in nature - temperature and humidity.

- If the modules are used in a special installation environment, please consult the technical support department of Sunman in advance.
- The installation surface should be flat without bumps or pits.
- The modules must not be installed near flames or flammable objects.
- Do not expose modules to artificial condensing light sources
- The modules should not be immersed in water (pure water or salt water), installed in long-term water environment (pure water or salt water) (eg fountains, sprays, etc.) or area prone to water accumulation (eg roof drain, low-lying areas, etc.).
- Please consult SMF installation manual for Flat roofs if roof area has poor drainage or extended water pooling.
- If the module is placed in a salt mist (ie marine environment) or in an environment containing sulfur (ie, sulfur sources, volcanoes, etc.), there is a risk of corrosion.

- **Failure to follow the above precautions, Sunman Warranty will be voided.**

### **Installation requirements**

- Ensure the modules meet the overall technical requirements of the system.
- Ensure that components of other systems do not damage the mechanical or electrical performance on the modules.
- Connect modules in series to increase voltage or in parallel to increase current. When connected in series, the positive pole of the module is connected to the next negative pole. When connected in parallel, the positive pole of the module is connected to the positive pole of the next module.
- The number of bypass diodes provided varies depending on the module model.
- Connect the appropriate number of modules according to the voltage specifications of the inverter used in the system. Even at the lowest local temperature conditions, the connected modules must produce no more than the voltage allowed by the system. If overcurrent protection devices (fuse) are not used in series within each string of modules, up to two strings of modules can be connected in parallel. If a suitable overcurrent protection device is connected in series with each string of modules, three strings or more modules can be connected in parallel.
- In order to avoid (or reduce) the mismatch effect of the array, it is recommended to connect modules of similar electrical performance on the same string.
- In order to reduce the risk of indirect lightning strikes, loops should be avoided when designing the system.
- The modules should be securely fastened to withstand all possible loads, including wind and snow loads.

### **Optimal orientation and inclination**

- In order to achieve maximum annual power generation, the optimal orientation and inclination of the PV module should be determined first. The maximum electrical energy is typically generated when sunlight is directed onto the PV module.

### **Avoid shadows**

- Even small shadows (such as dust) can cause a drop in power generation. If all surfaces of the module are uncovered throughout the year, the module is considered "no shadow". Ensure that the sun shines on the modules even on

the shortest day of radiation all through the year.

- EVA aging caused by frequent occlusion of modules and long-term heating of the diode can affect the lifetime of the module.

## 5.1 Module wiring

### Correct electrical wiring

- Check that the wiring is correct before starting the system. If the measured open circuit voltage (Voc) and short circuit current (Isc) do not match the specifications provided, there may be a wiring fault.

### Correct connection of the MC4 connector

- Make sure the MC4 connector is secure and properly connected. The MC4 connector must not be subjected to external pressure. The MC4 connector can only be used for circuit connection functions and should not be used to turn the circuit on and off.
- The MC4 connector should be kept dry and clean to prevent rain and moisture. Avoid direct sunlight and water immersion of the MC4 connector.

### Use appropriate materials

- Depending on local fire, construction and electrical standard, use dedicated solar cables and suitable MC4 connectors to ensure the electrical and mechanical performance of the cable.
- The solar cable licensed for use is a single-wire cable, 2.5-10mm<sup>2</sup> (8-14 AWG), 90°C grade, with appropriate insulation to withstand the maximum possible system open circuit voltage. The appropriate wire size needs to be chosen to reduce the voltage drop. The wire should be made of copper.

### Cable protection

- Secure the cable to the mounting system with a cable tie that is UV resistant. Appropriate measures should be taken to protect the exposed cable from damage (eg. in a plastic sleeve with UV aging resistance). Avoid direct exposure of the cable to direct sunlight.

## 5.2 Grounding

- With adhesive on the back of SMF modules, there is no metal conductor for the module, so no grounding of module is required.

## 6.0 Installation instructions

### 6.1 Module and tools

#### 6.1.1 Module

Applicable module model: SMF430F-12X12UW, SMF430F-6X24UW

The electrical performance parameters are detailed in Annex A.

#### 6.1.2 Construction materials

- Aluminum channel / PVC support rail, Adhesive (glue), primer, gluing gun, plastic roller, cleaning tool, tape measure, thread release tool, etc.
- Support rail

The aluminum material should be 6063-T5/T6. Minimum size recommended size will be as per the below

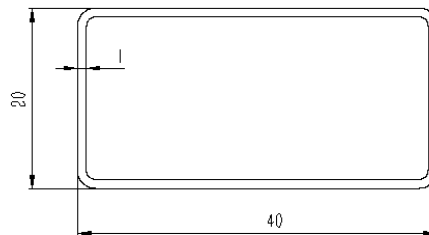

The PVC rail should be provide by Sunman approved supplier

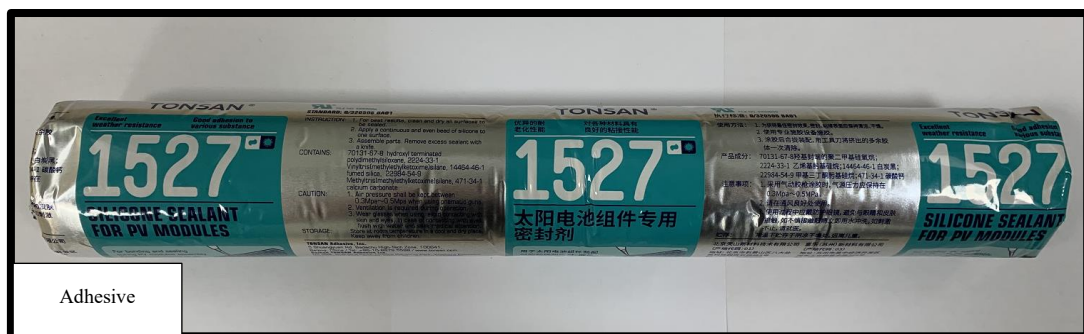



## 6.2 Unpacking, Handling and Checking Precautions

- Do not open modules outer Package before installation.
- Check the outer package for damage before unpacking.

- Slip-Proof Gloves are recommended for unpacking and handling.
- Do not grab the modules by the junction box or cables during unpacking or handling.
- Modules should be handled and lifted by at least two people. Do not touch the solar cell area during handling to avoid damage to the cells.
- Be careful while carrying the modules. Avoid hitting the modules on the ground or other sharp, hard objects. Scratches will affect the module's safe operation.
- Check the surfaces of the modules. Ensure there's no damage to the frontsheet and the backsheet.
- Check the junction box, connectors, and cables for any damage. Double check if the junction box cover is fixed securely.
- Do not paint or apply glue or label on the surface of the modules.

### 6.3 Construction Precautions

- Normal construction can be carried out in the temperature range of -10 to 45 degrees Celsius (5 to 40 degrees Celsius is the best), and the humidity is below 80 %RH.
- The surface of the roof and support rails must be cleaned or wiped dry, free of floating soil, oil, etc. In order to achieve the required adhesion, the roof shall be cleaned using the cleaning agent specified in Annex C or Sunman- approved cleaning agent.
- After initial installation, the panel and adhesion shall not be disturbed for 24 hours.
- The roof angle is within 45 degrees from the horizontal.
- The paste surface needs to be flat and free of pits or bumps.
- The height of the structural adhesive after pasting should not be less than 3mm.
- Support rail should be laid along the direction of the roof water flow, to ensure smooth drainage (preferred)
- When the laying direction of the support rail is perpendicular to the direction of the water flow, the rail and the roof should be pasted intermittently to ensure smooth drainage (not recommended)

## 6.4 Precautions and Tips for Gluing Modules

- Please make sure the surface is cleaned and there are no water on the surfaces before gluing;
- Glue along the middle line of the trapezoid or wave crest. Width of silicone glue beads should exceed 10 mm and height of the beads should exceed 5 mm
- Apply the silicone glue with a continuous and smooth movement. Do not smooth out the lines of glue to spread them out;
- Be sure to complete the mounting of the panel or supports within 5 minutes of applying the glue to ensure that the glue does not build a skin;
- Silicone sealant will cure to a depth of 2-3mm in 48 hours. Do NOT apply any force on the module before curing is complete;

## 6.5 Construction plan

Note: The installation steps are for TPO roofs, for reference only, different roof types can refer to this step for construction.

### Installation steps

#### 6.5.1 Cleaning the roof surface

Remove debris from the roof base and use a designated or approved cleaning agent (Annex C) to clean the roof. If the roof is very dirty, use a low-pressure water spray or power washer before using the cleaner. Optionally, use a mixture of 1/4 cup of trisodium phosphate, 1/2 cup of liquid cleaner and 5 gallons of water for cleaning.

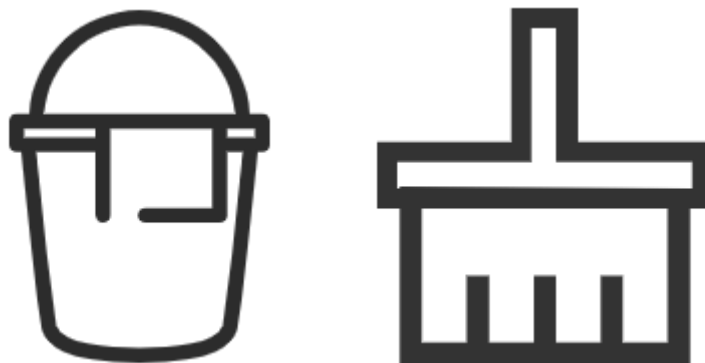

#### 6.5.2 Positioning

- Positioning and securing lines to determine the spacing of aluminum channel or CS supports in accordance with the design drawings (For design drawings,



please contact Sunman).



### 6.5.3 Apply primer (ignore this step if no primer required for the roof material)

- Determine the gluing area of the modules after the roof cleaning (refer to the design drawing for specific dimensions);

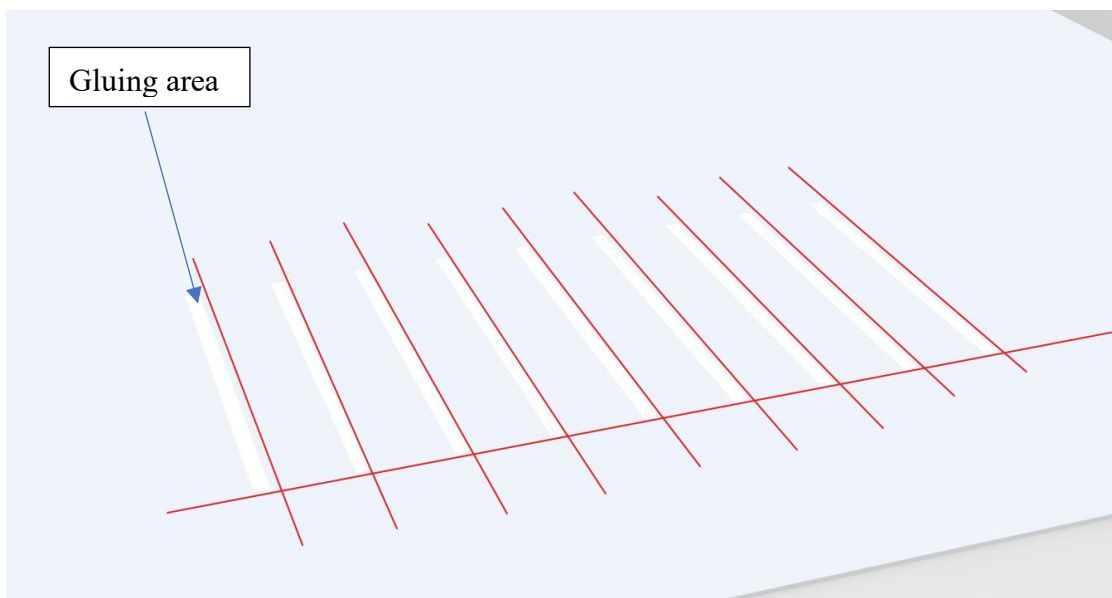

- Clean the gluing area again, wipe the area with the cleaning agent in Annex C;
- For the gluing area, apply primer before gluing (see Annex B for different types of roof primer).



#### 6.5.4 Apply primer for PVC rail (ignore this step for the aluminum rail)

- Clean the bonding surface of PVC rail with a clean wet wipe. No debris, dust and ash on the bonding surface shall be present after cleaning. No water stains on the paste surface after wiping shall be present during the next step of construction
- Apply primer on both side of PVC rail. Open the cap of the primer bottle, cover the top of the bottle with a clean cotton cloth or non-woven fabric, and reverse the bottle for a few seconds so that the primer can moisten the cotton cloth or non-woven fabric.



- Use cotton cloth or non-woven fabric to apply primer along both side of PVC rail. Only a light coat is required. More coating is not beneficial.
- After 5 minutes of primer application when the primer has dried, continue with the installation of the glue. The glue needs to be completed within 2 hours of the application of the primer. If more than 2 hours have passed after the application of the primer, it will need to be reapplied.

#### 6.5.4 Paste rail

- Install the glue on the rail according to the section 6.4
- The two supports that are installed at the ends of each panel shall have a continuous bead of glue. The supports that are installed in the middle of the panel can be glue in sections. The bead length in these sections shall be minimum 200mm. The distance between supports and glue length in middle can be adjusted according to an assessment done of the site.

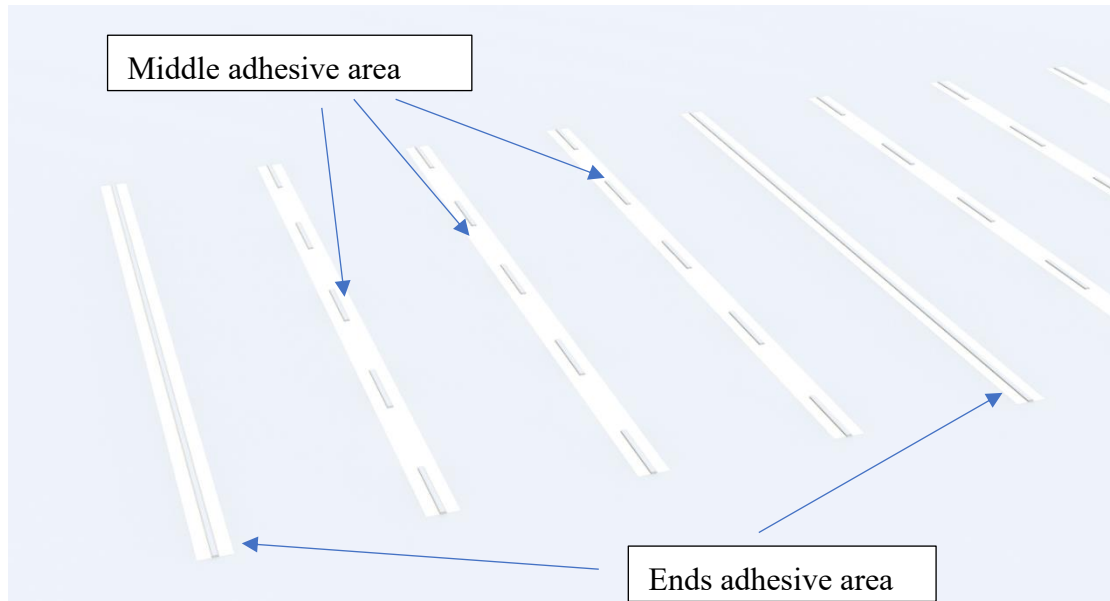

- Paste the rail along the gluing path and lightly compress. Ensure the bead height is not less than 3mm



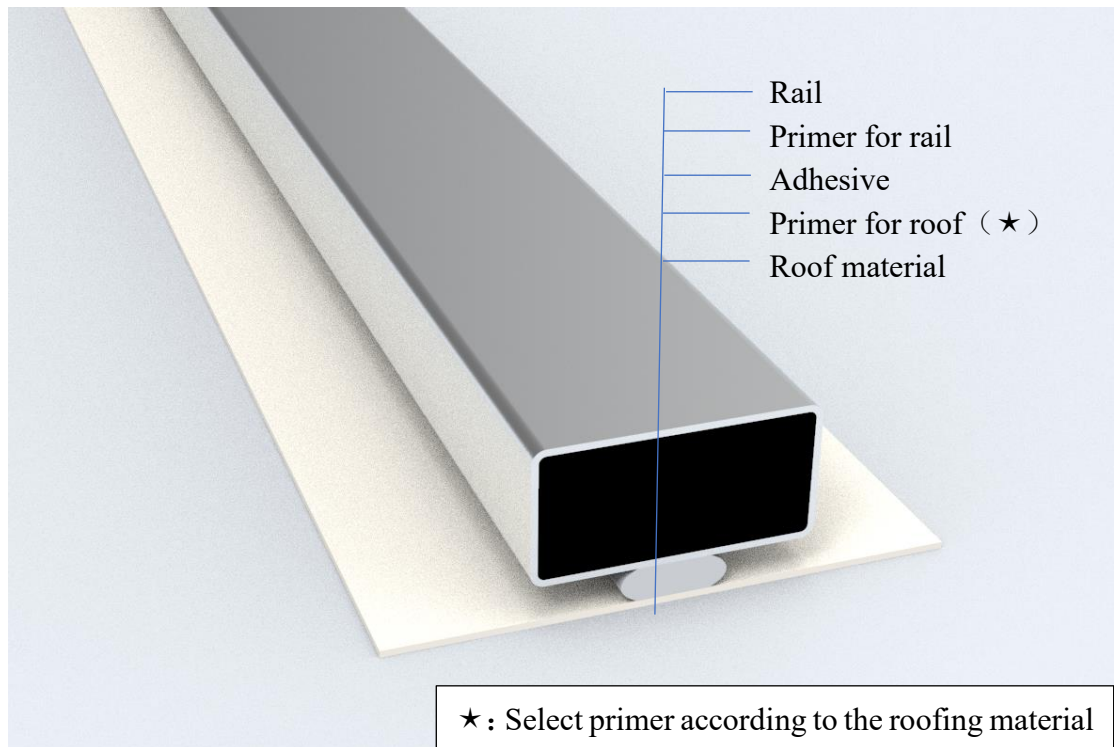

#### 6.5.4 Laying modules

- Making Glue on the rail followed the Precautions and Tips for Gluing Modules;



- The two supports that are installed at the ends of each panel shall have a continuous bead of glue. The supports that are installed in the middle of the panel can be glue in sections. The bead length in these sections shall be minimum 200mm. The distance between supports and glue length in middle can be adjusted according to an assessment done of the site.



- Do not bend the module during installation. Two people should grasp the white edge of the module and place it onto the glue. Modules should be in a straight position during placement. Do not re-glue the modules.
- Once modules are placed, avoid hand-pressing the cell-area to facilitate adhesion. Instead use a compaction roller to press the edge (non-cell area) of the module down. Also use a Plastic roller to apply gentle force to the cell area to facilitate adhesion.
- The minimum distance between the modules is 2mm, and the distance between each array is 500-800mm, which is used as a construction maintenance walkway. (refer to the pictures)
- If the module is selected as 12\*12 series (the junction box is in the long side direction of the module), the junction box side should be placed at the edge position for wiring and maintenance.
- Install remaining modules according to the preceding steps

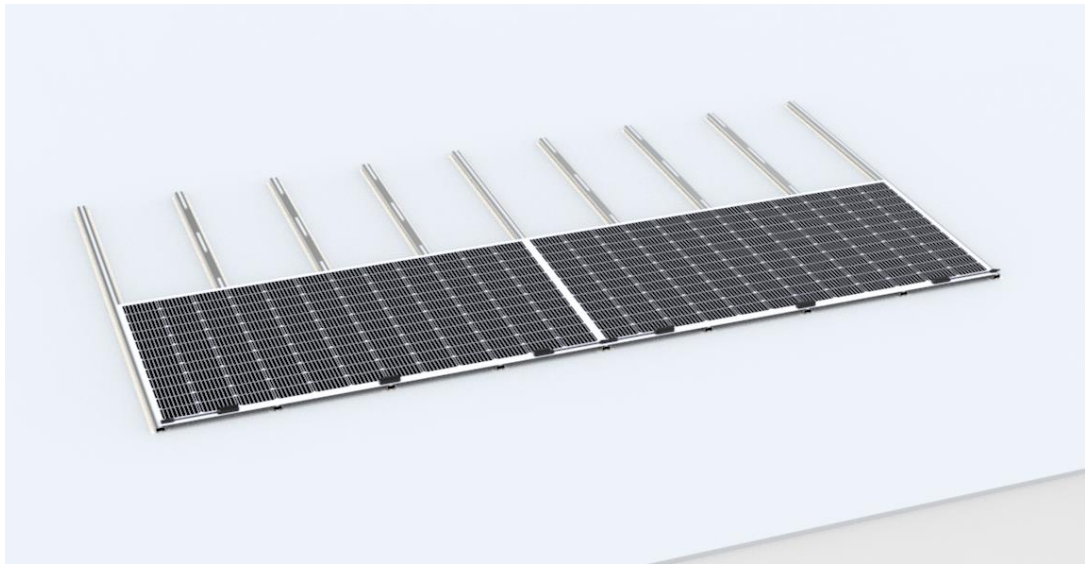



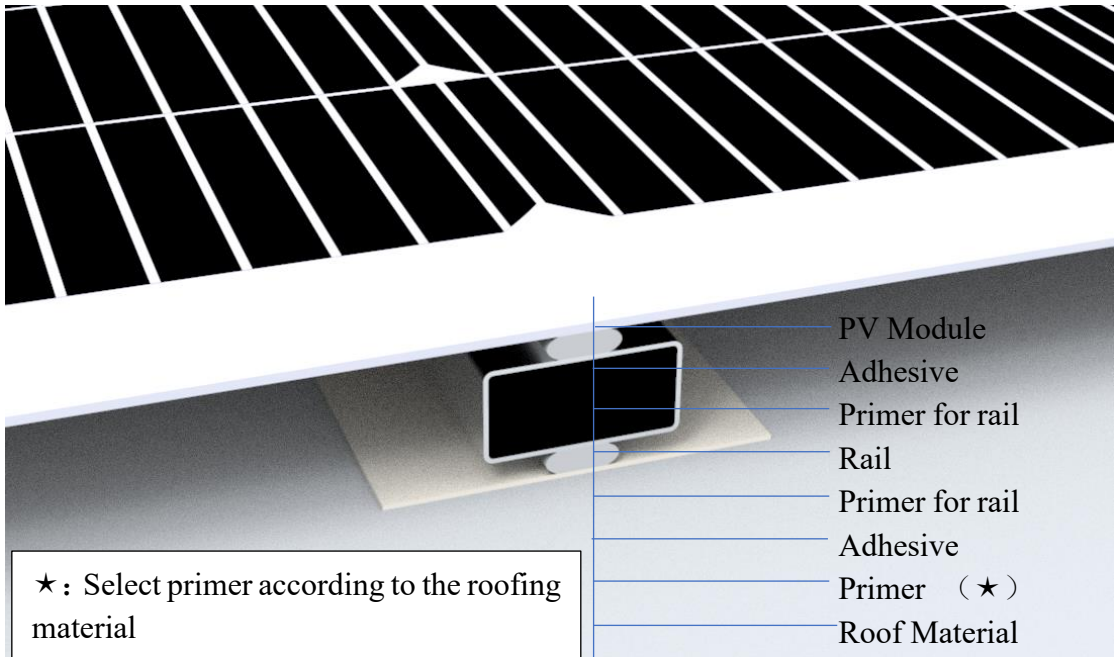

### 6.5.4 Joint of rails

During the project installation process, the rails need to be combined into a longer square rail, please strictly follow the following two methods to operate:

Method one: Put the joint between two modules

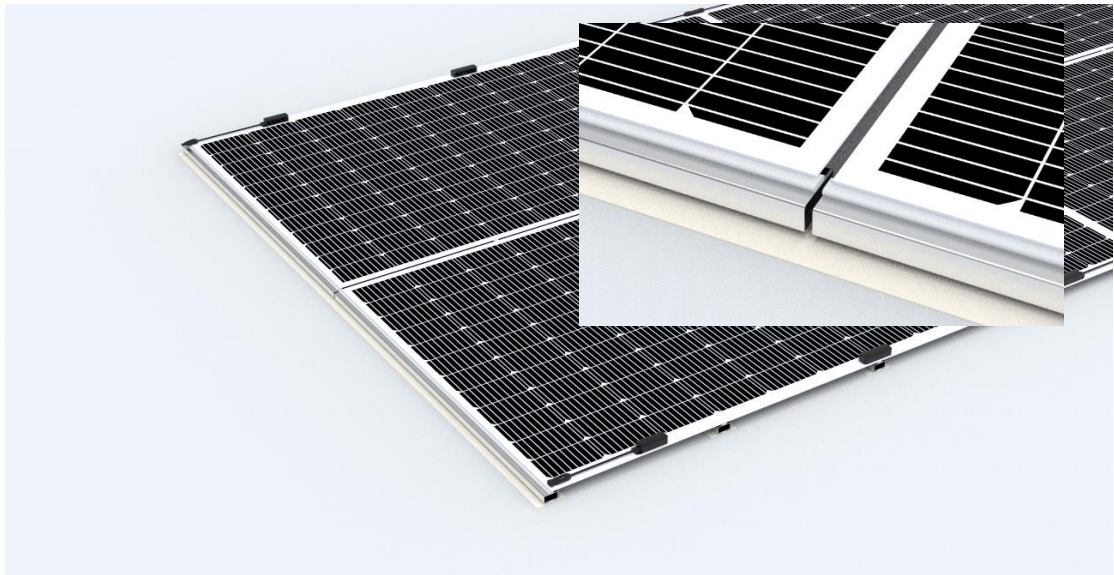

Method two: The joint be fixed with connectors and fasteners.

Connection style is for reference only, can be customized according to the actual situation of the project suitable for the connection

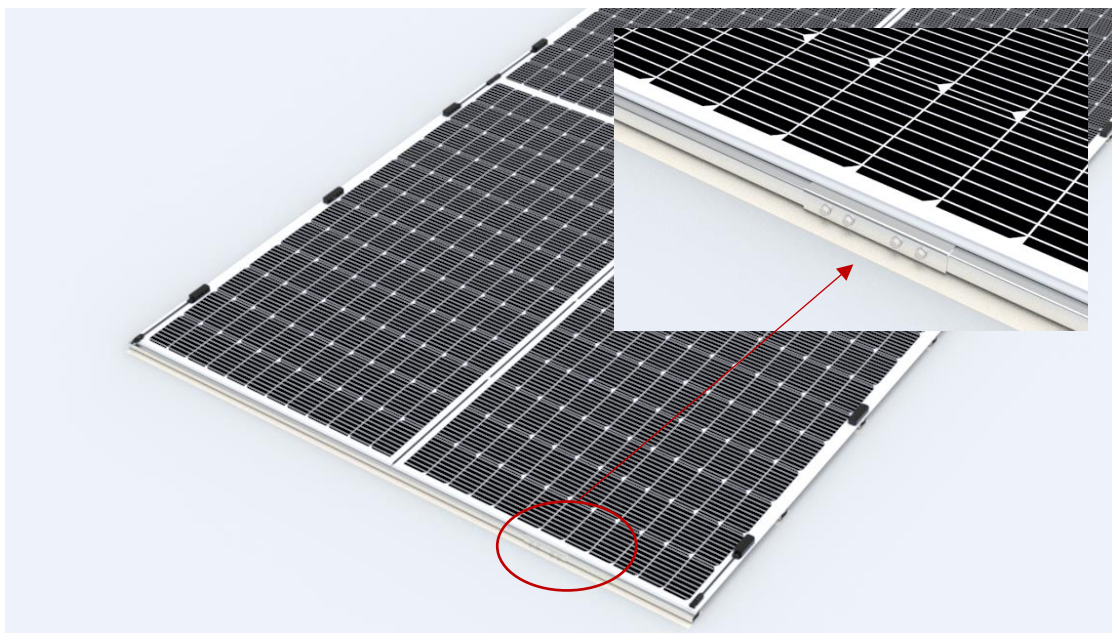

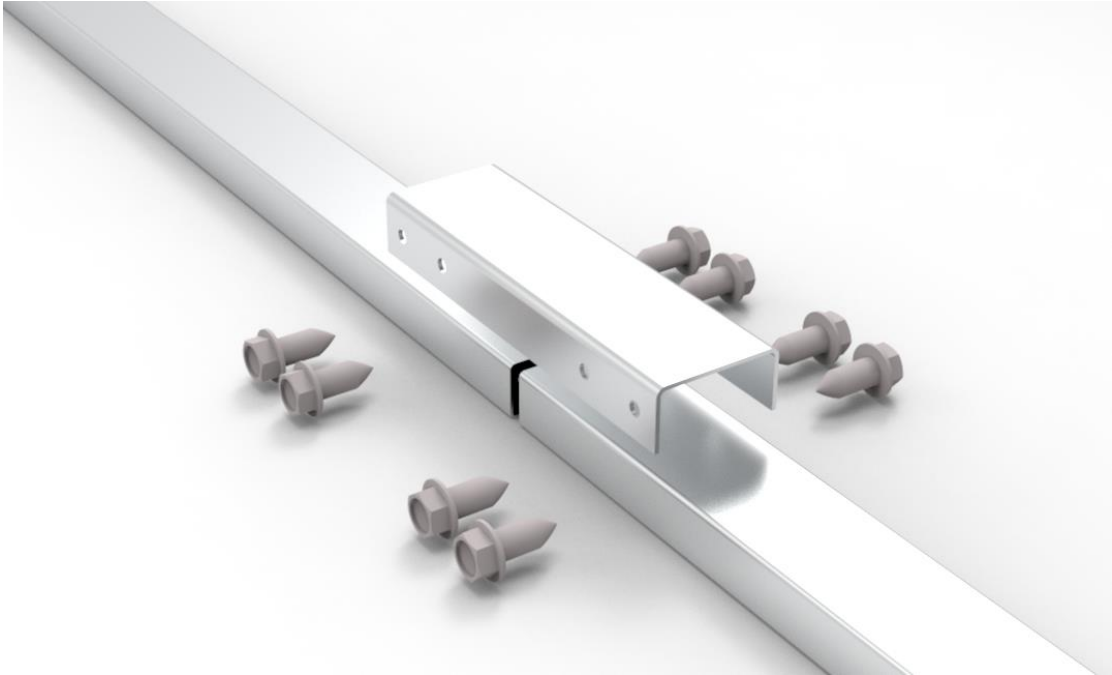

## 6.6 Wiring and testing

- The use of PV modules with different configurations in a PV system is prohibited.
- Excessive cables must be organized or fixed in the proper location and shall not shade the solar cells.
- For applications requiring high operating voltages, several PV modules may be connected in series to form a PV string, then the system voltage is equal to the sum of the voltages of each PV module
- For applications requiring high operating currents, several strings of PV modules can be connected in parallel to form a PV string, then the system current is equal to the sum of the currents of each PV module string.
- A maximum system voltage of 1000VDC is allowed.
- The maximum number of PV modules in series depends on the system design, the type of inverter used and the environmental conditions;
- Depending on the maximum series fuse rating of the PV module and local electrical installation codes, if the PV module does not have any fuses or blocking diodes, make sure to connect no more than two strings in parallel;
- There is no limit to the number of PV modules that can be connected in parallel (fuses per string should be considered), the number of PV modules



is determined by system design parameters such as current or power output;

- Please refer to local regulations to determine the size, type and temperature of the system conductors;
- PV modules are equipped with connectors for system electrical connections, please refer to local regulations and data sheets that allow the use of connectors;
- To ensure a reliable electrical connection and to prevent possible moisture ingress, connectors must fit and lock together until a click is heard;

The DC power generated by the PV system can be converted to AC power and connected to the public grid, as the local power company's policy for connecting renewable energy systems to the grid varies from region to region. You can ask your PV system design engineer or integrator for help in obtaining building permits, inspections and approvals from your local power company's department.

## 7.0 Maintenance

To ensure optimal performance of modules and maximize system power generation, the following maintenance measures are recommended:

1 Module appearance inspection, focusing on the following points:

- a) Whether the module is damaged.
- b) Whether there is a sharp object touching the surface of the module.
- c) Whether the modules are obstructed by obstacles and objects, avoiding new trees, new poles etc. to shielding the modules.
- d) Check for corrosion near the busbar. This kind of corrosion is caused by the damage of the module surface during transportation, which causes moisture to penetrate into the interior of the module.
- e) Check the adhesive between the module and the roof for looseness or damage and adjust or repair it in time.

2 Clean the modules. The accumulation of dust or dirt on the surface of the modules will reduce the power output. It should be cleaned regularly to keep the surface clean. Generally, it should be cleaned at least once a month, appropriately increase the frequency in the harsh natural environment. Pay attention when cleaning PV modules:

- a) Rinse with water first, then dry the water with a soft cloth. Do not use corrosive solvents to clean or wipe the PV modules with hard objects.
- b) The PV module should be cleaned at an irradiance of less than  $200 \text{ W/m}^2$ . It should be cleaned in the absence of sunlight or in the morning and evening.
- c) It is strictly forbidden to clean PV modules under meteorological conditions where the wind is greater than grade 4, heavy rain or heavy snow.

**Note: Do not walk, stand or sit on the module when cleaning.**

3 Connector and cable inspection. It is recommended to conduct a preventive inspection every six months:

- a) Check for signs of aging of PV modules, including possible rodent damage, weathering, and whether all connectors are tightly connected or corroded.

## Annex A

### Electrical performance parameter

Series	Products	STC					module size
		Pmp	Vmp	Imp	Voc	Isc	
	SMF430F-12X12UW	430	42.0	10.24	49.8	10.74	2054*1084*2
	SMF430F-6X24UW	430	42.0	10.24	49.8	10.74	2120*1046*2

## Annex B

### Installation for different roof materials

Roof type	Primer for roof	Primer for PVC rail	Adhesive
TPO	Contact Sunman	Seal-it® 525	Tonsan 1527 Innotec versabond
Concrete	Contact Sunman	Seal-it® 525	Tonsan 1527 Innotec versabond
Glass	/	Seal-it® 525	Tonsan 1527 Innotec versabond
PVC	/	Seal-it® 525	DIMA MS8201 Innotec versabond
Bitumen	/	Seal-it® 525	Innotec versabond Seal-it® 380
EPDM	/	Seal-it® 525	Tonsan 1527 Innotec versabond

## Annex C

### Cleaning agent

Roof type	Cleaning agent recommended by Sunman
TPO, PVC, Asphalt, EPDM, etc. plastic roof	Plastic cleaner China: RA-1033 Overseas: Use the cleaning agent recommended by the roofing material supplier
Color steel tile, glass roof, metal roof	90% isopropanol + 10% water

Use the cleaners listed above or those recommended by the roofing material supplier.



## Annex D

### Gluing operation specification

#### 1. Gluing nozzle cutting

The standard nozzle cutout is 10.5mm x 6mm, which is made by cutting about 20mm from the original nozzle and flattening it to the required size, as shown in the figure below.

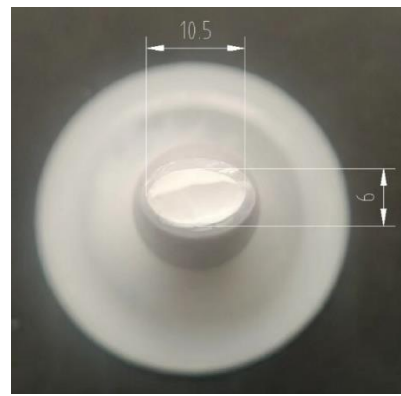

Nozzle cutting should be carried out in strict accordance with the following procedures.



Standard tool shears (complimentary with adhesive)

## Operation steps



1. Use a straightedge or tape measure to measure the length of the head of the nozzle 20mm, confirm the cutting position, and then use the tool to cut in addition.



2. It is recommended to use a lighter to heat the tip of the rubber nozzle for about 2s to prevent it from springing back after being flattened.



3. Squeezing of the nozzle to the desired size using a flattening die of the tool shears.

## 2. Electric glue gun adjustment

Standard glue-out speed: Half turn of the speed knob, see the following figure:



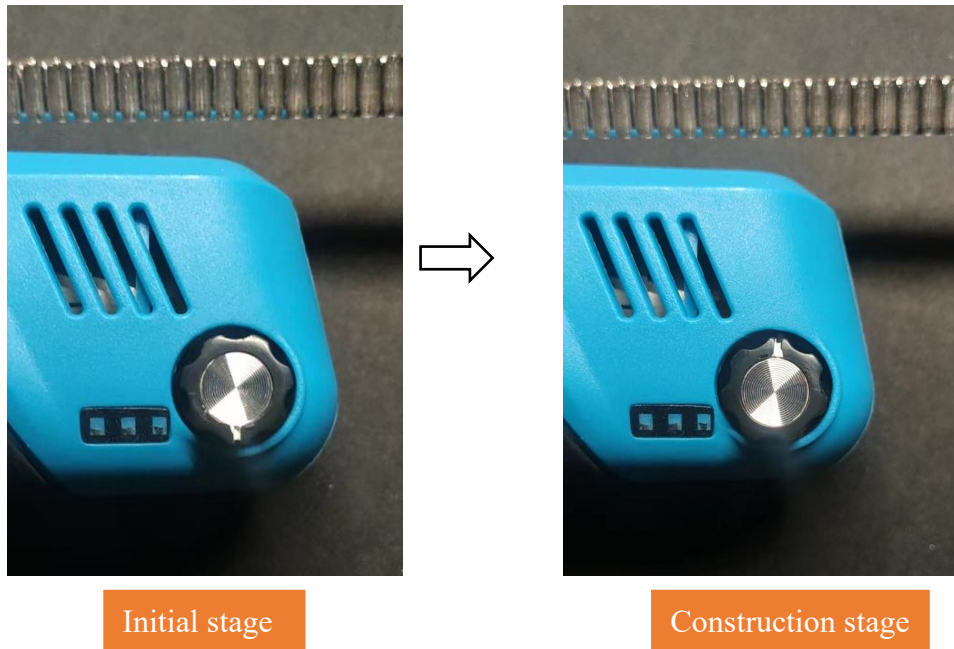

### 3. Gluing parameters

Gluing length: 10.8m/600ml on average

Gluing speed: about 10cm/s

Gluing angle: the glue gun is at an angle of about  $40^{\circ}$  with the ground, as shown in the following figure:

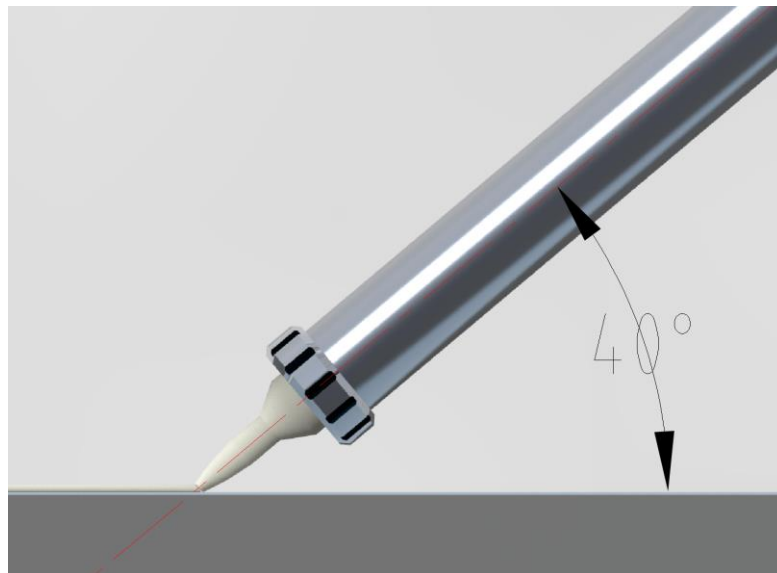







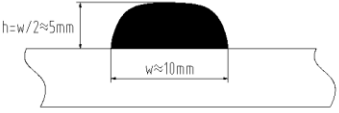

Adhesive size and standard dosage: at least 10\*5mm; 5 strips/1 module (adhesive along the width of the PV module); 3 strips/1 module (adhesive along the length of the PV module)







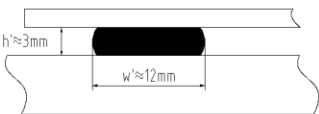

#### 4. Structural adhesive form

Please see below for proper bead application

	
 Correct dimension	 Too flat
	
 Too high, too small	 Poor wetting

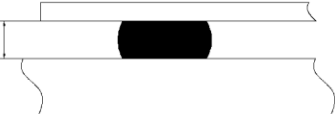
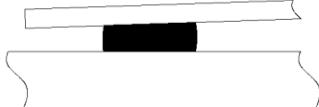
The correct form of structural adhesive after pasting modules

	
 Correct dimension	 Too flat
	
 Too high	 Inclined

## Annex E

### Unpacking

Standard unpacking steps for light weight PV modules.



1. Remove all wrapping film and packing tape outside the package



2. Remove packing box cover (keep well for another purpose)

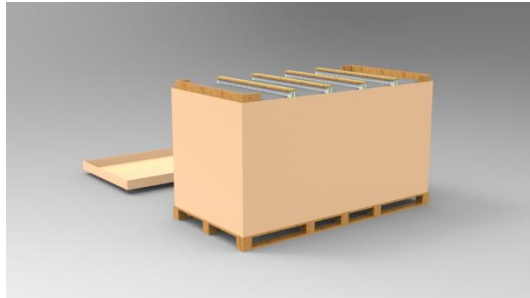

3. Place the cover next to the box with the opening up



4. Remove the outer packaging carton



4.1. Box cover retention (handling module auxiliary parts)



5. Remove the upper fence on the side of the wooden box, keep the lower fence

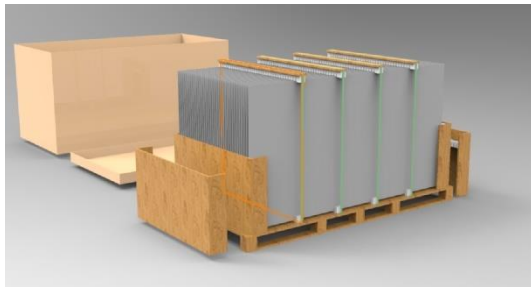
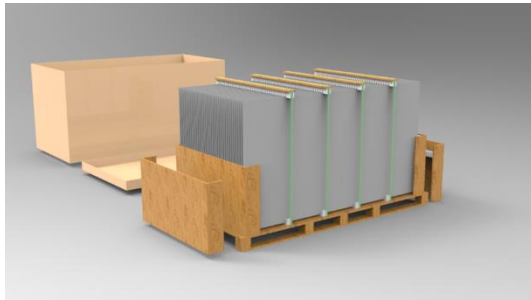

6. Use scissors or a hobby knife to cut off the packing tape used to secure the module (do not cut the module)

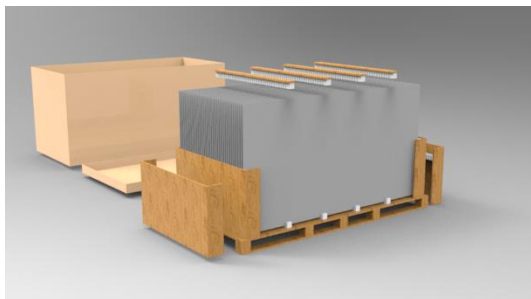
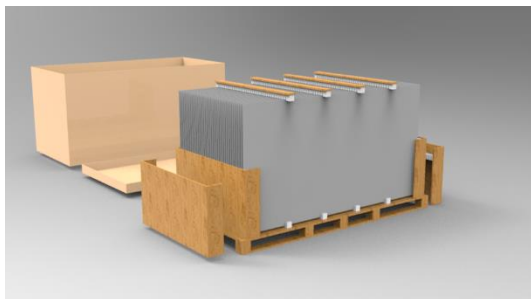

7. Remove the fixing clip above the module

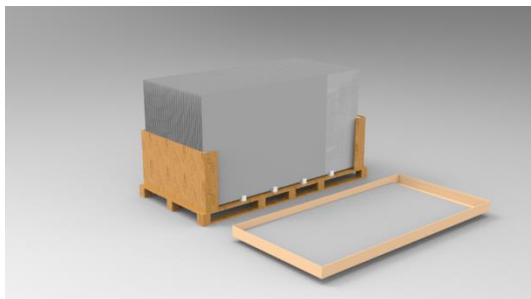
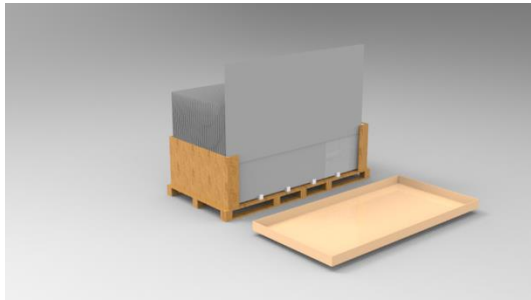
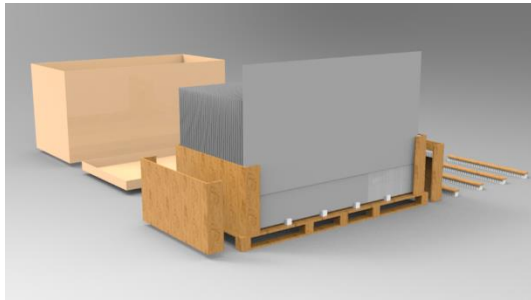
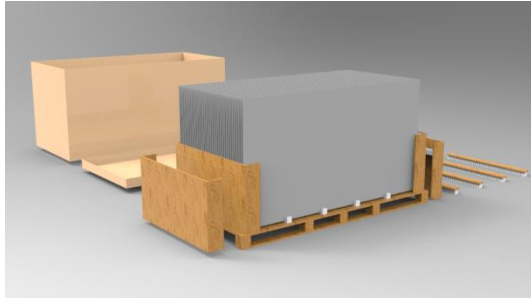

8、 To pick up the module, please raise the module to the height of the lower C-shaped enclosure and move out the module

When picking up the module, please grab the non-cell white area of the module.

When picking up the module, grab the long side direction of the module, the short side direction of the module can only be short grabbed again when out of the box operation

9、 Place the box cover open side up and transport the module flat inside the cover to the project designated installation site  
Place a maximum of two modules in the cover, separated from each other with foam inside the box

Use a minimum of four foam strands, placed evenly between the stacked modules.

**Module stacking and handling operations are as follows:**

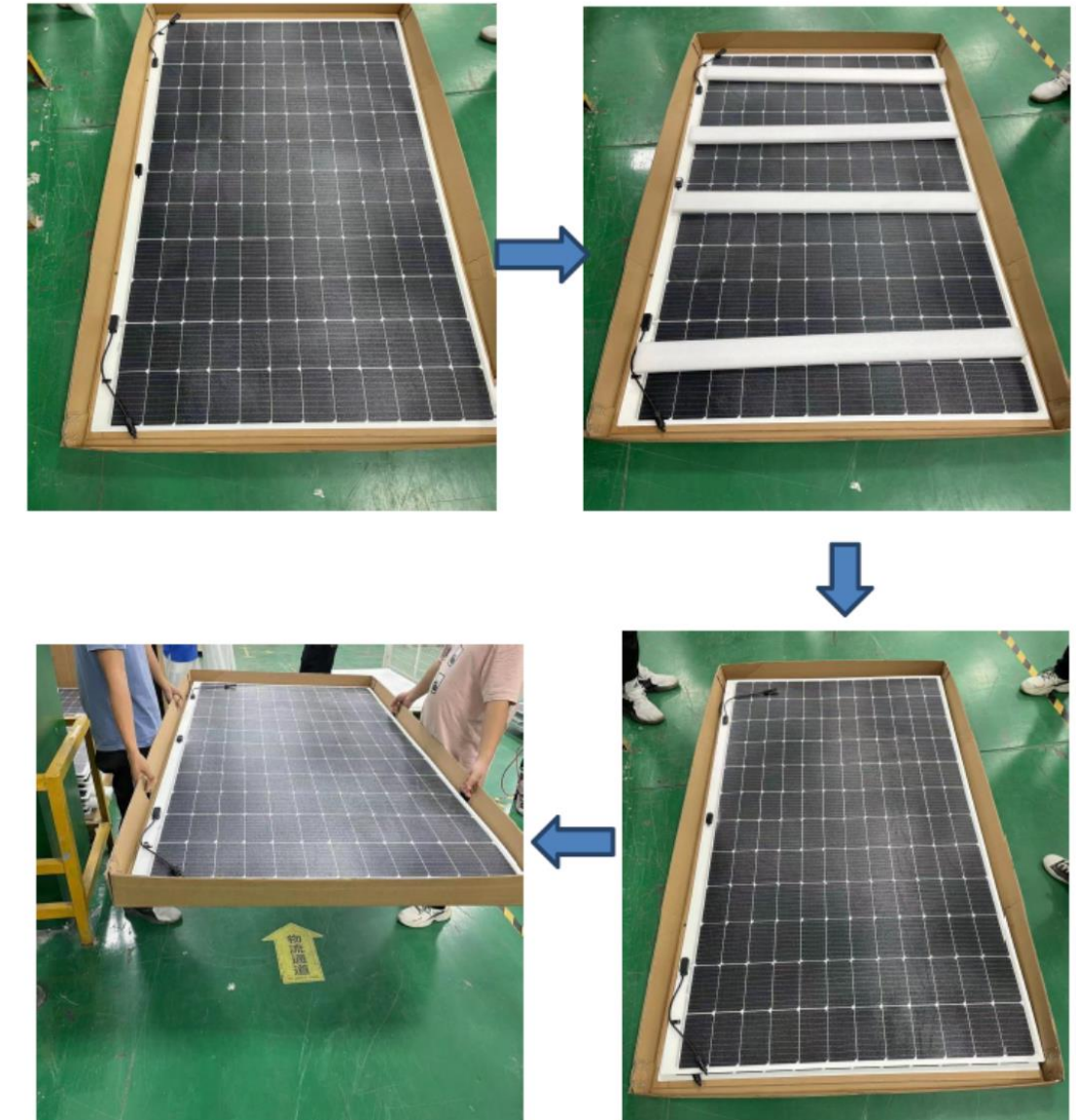

### **Unpacking precautions**

Avoid operating in rainy weather when opening cartons outdoors.

Secure the modules when operating outdoors in windy conditions.

Stack components in a ventilated, rain-proof, and dry area before unpacking them.

Do not to damage the front or back of the module when using scissors or hobby knife to cut the outer packing tape.

Confirm the number of modules in the box promptly after unpacking.

The unpacking area needs to ensure that the box is placed horizontally and stably to avoid tipping of the modules.



During unpacking and handling, please wear protective gloves properly to avoid scratches.

Prohibit pulling on junction boxes or cables under any circumstances.

When handle the modules, avoid touching the cell area with hands.